

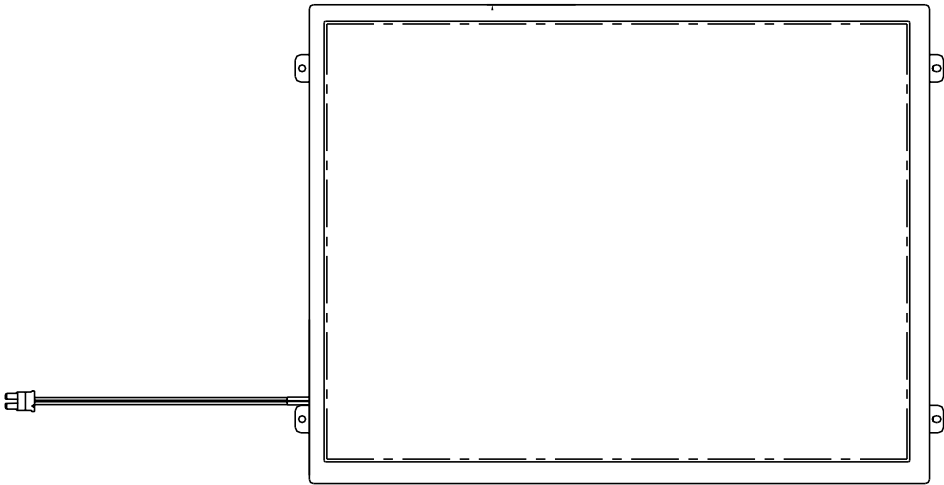

PRODUCT SPECIFICATION

HDA1040X

10.4", TFT XGA (1024X768) COLOR  
LCD DISPLAY MODULE



HANTRONIX, INC. 10080 BUBB RD. CUPERTINO, CA 95014	Q.A.:	REV:	HDA1040X	SHEET 1 OF 15
	ZW	1.0		DATE: 7/28/08

## OVERVIEW

**HDA1040X** is 10.4" color TFT-LCD (Thin Film Transistor Liquid Crystal Display) module composed of LCD panel, driver ICs ,control circuit and backlight. By applying 1024×768 images are displayed on the 10.4" diagonal screen. Display 262K colors by 6 Bit R.G.B signal input.

General specification are summarized in the following table:

ITEM	SPECIFICATION
Display Area (mm)	211.2(W)×158.4(H) (10.4-inch diagonal)
Number of Pixels	1024(H) × 3(RGB) × 768(V)
Pixel Pitch (mm)	0.20625 x0. 20625
Color Pixel Arrangement	RGB vertical stripe
Display Mode	Normally white, TN
Number of Colors	262,144
Optimum Viewing Angle	6 o'clock
Brightness (cd/m <sup>2</sup> )	300nit(typ)
Response Time (ms)	25ms (typ)
Viewing Angle(BL on,CR ≥ 10)	140 degree (Horizontal.)
	120 degree (Vertical)
Power Consumption	6.41w(typ)
Electrical Interface(data)	LVDS
Module Size (mm)	236(W)×174.3(H)×7.4(D)
Module Weight (g)	380(typ)
Backlight Unit	CCFL
Surface Treatment	Anti-Glare Hardness:3H

HANTRONIX, INC.  
10080 BUBB RD.  
CUPERTINO, CA 95014

Q.A.:  
Z.W.

REV.:  
1.0

**HDA1040X**

SHEET 2 OF 15

DATE: 7/28/08

## ABSOLUTE MAXIMUM RATINGS

The following are maximum values which, if exceeded, may cause faulty operation or damage to the unit.

Item	Symbol	Min.	Max.	Unit	Note
Power Supply Voltage	Vcc	-0.3	4.0	V	
Singal Input Voltage	RxIN0+ ~ RxIN2+ RxIN0- ~ RxIN2- Rx CLK IN +/-	-0.3	Vcc+0.3	V	
Lamp Voltage	VL	729	946	Vrms	
Lamp Current	IL	4	8	mArms	【Note 4】
Lamp Frequency	FL	40	80	KHz	【Note 4】
Static Electricity	VESDc	-200	200	V	【Note2】
	VESDm	-15K	15K	V	
ICC Rush Current	IRUSH	--	1	A	【Note 3】
Operation Temperature	T <sub>op</sub>	-20	70	°C	【Note 1】
Storage Temperature	T <sub>stg</sub>	-30	80	°C	【Note 1】
Discharge Time Lag	TD	--	1	sec	【Note 6】

【Note】

【Note1】

If users use the product out off the environment operation range ( temperature and humidity ) ,it will concern for visual quality.

【Note2】

Test Condition: IEC 61000-4-2 ,

VESDc : Contact discharge to input connector

VESDm : Discontact discharge to module

【Note3】

The input pulse-current measurement system as below :

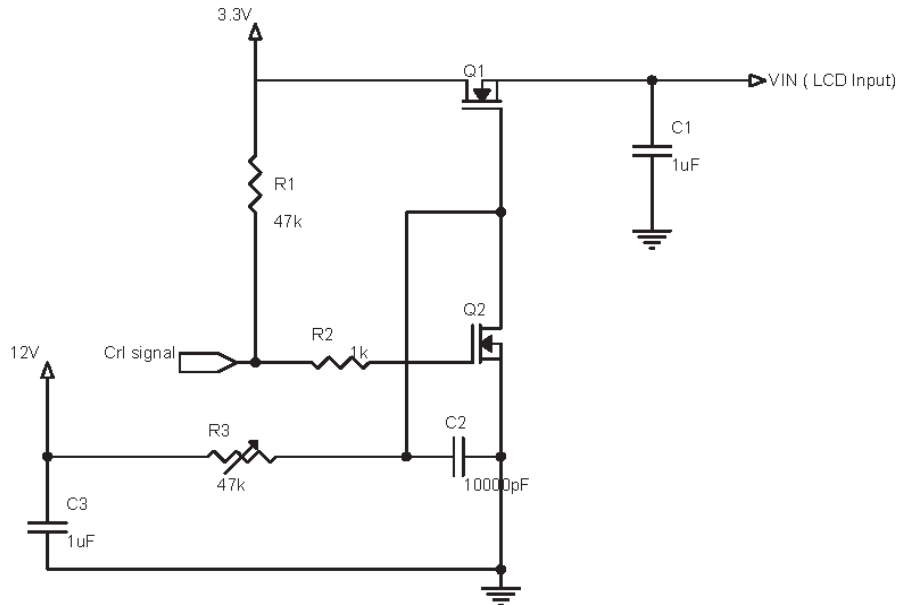

HANTRONIX, INC.  
10080 BUBB RD.  
CUPERTINO, CA 95014

Q.A.:  
Z.W.

REV.:  
1.0

HDA1040X

SHEET 3 OF 15

DATE: 7/28/08

Control signal: High(+3.3V)→Low(GND)

Supply Voltage of rising time should be from R3 and C2 tune to 550  $\mu$ s.

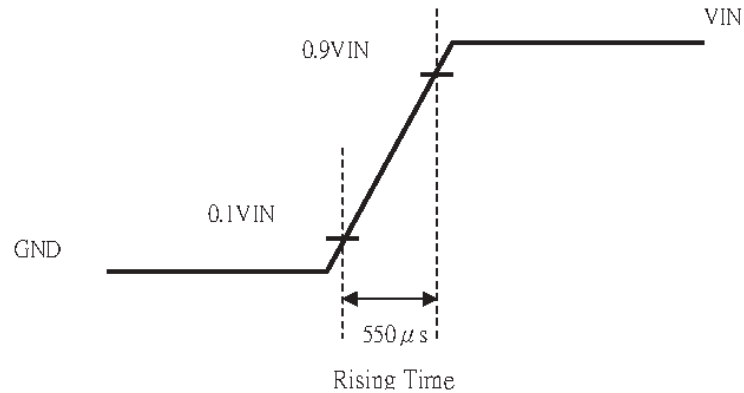

**【Note 4】**

Table of specifications are definition of single lamp .

**【Note 5】**

The frequency is operated in the range, will not influence the life of lamp and display characteristic.

**【Note 6】**

The time needed to start discharge when the over Starting Lamp Voltage is continuously applied to both ends of the lamp. Before testing, the lamp is left in the dark room (ambient temperature :  $25\pm 2^\circ$  ; ambient illuminance : less than 0.1 lux) for 24Hr after lighted for 1 minute at rated lamp current. The testing shall be conducted in the dark room. And the sealing side shall be connected to high voltage side. (ambient temperature :  $25\pm 2^\circ$  ; ambient illuminance : less than 0.1 lux). The minimum safety time for the inverter need over the maximum time for the start discharge .

HANTRONIX, INC. 10080 BUBB RD. CUPERTINO, CA 95014	Q.A.:	REV.:	HDA1040X	SHEET 4 OF 15
	Z.W.	1.0		DATE: 7/28/08

## ELECTRICAL CHARACTERISTICS

### TFT LCD

Ta=25° •

Item	Symbol	Min.	Typ	Max.	Unit	Note	
Power Supply Voltage For LCD		V <sub>CC</sub>	3.0	3.3	3.6	V	
Logic Input Voltage (LVDS:IN+,IN-)	Common Mode Voltage	V <sub>CM</sub>	1.08	1.2	1.32	V	*1)
	Differential Input Voltage	V <sub>ID</sub>	250	350	450	mV	*1)
	Threshold Voltage(high)	V <sub>TH</sub>	-	-	100	mV	*1) V <sub>CM</sub> =+1.2V
	Threshold Voltage(low)	V <sub>TL</sub>	-100	-	-	mV	*1)

Remarks :

\*1)LVDS signal

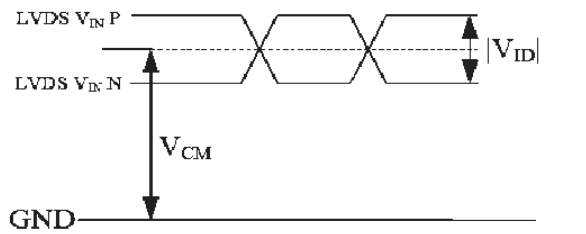

$|V_{ID}| = |V_{TH} - V_{TL}|$   
 $V_{CM} = (V_{TH} + V_{TL})/2$

### TFT-LCD Current Consumption

Item	Symbol	Min	Type	Max	Unit	Notes
LCD power current	ICC	-	420	600	mA	*1)

Remarks:

\*1) Typical: Under 64 gray pattern  
Maximum: Under black pattern



(a) 64 Gray Pattern



(b) Black Pattern

### 3.3 Power - Signal sequence

$t_1 \cdot 40\text{ms}$        $1 \text{ sec} \cdot t_5$   
 $0 < t_2 \leq 50\text{ms}$      $200\text{ms} \leq t_6$   
 $0 < t_3 \cdot 50\text{ms}$      $200\text{ms} \cdot t_7$   
 $0 < t_4 \cdot 40\text{ms}$

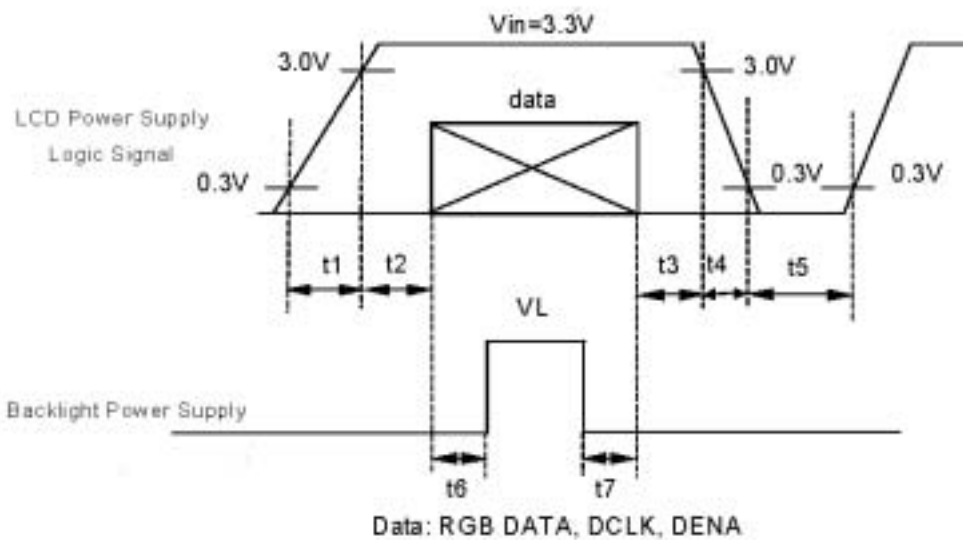

Backlight

Ta=25 •

ITEM	SYMBOL	MIN	TYP	MAX	UNIT	NOTE
Lamp current	IL	5.5	6.0	6.5	mArms	
Lamp voltage	VL	752	835	919	Vrms	*1); IL=6.0mA
Inverter Frequency	FI	40	50	60	kHz	*1). *2)
Start Lamp Voltage	VS	-	-	1400	Vrms	Ta=25°C *1).3)
		-	-	1500	Vrms	Ta=0°C *1).3)
				1700	Vrms	Ta=-20°C *1).3)
Lamp life time	IT	20,000	30,000		hr	*1).4), IL@6.0mA
Turn on and off life		100,000			times	*1).5), IL@6.0mA Continuous Operation Time Cycle 20 S.

If the driving waveform of lamp is asymmetric, the distribution of mercury inside the lamp tube will become unequally or will deplete the Ar gas in it. Then it may cause the abnormal phenomenon of lighting-up. Therefore, designers have to try their best to fill the conditions under the inverter designing-stage as below:

- The degrees of unbalance : < 10 %
- The ratio of wave height :  $< \sqrt{2} \pm 10 \%$

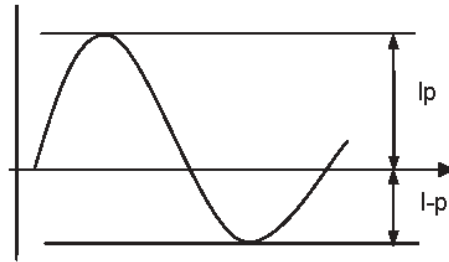

Ip : high side peak

I-p : low side peak

A : The degrees of unbalance =  $| Ip - I-p | / I_{rms} \times 100 (\%)$

B : The ratio of wave height =  $Ip \text{ (or } I-p) / I_{rms}$

[Note]

\*1) Table of specifications are definition of single lamp.

\*2) 1. Frequency in this range , the characteristics of electric and optics can maintain in  $\pm 10\%$  except hues.

2. Lamp frequency of inverter may produce interference with horizontal synchronous frequency (or vertical synchronous frequency), and this may cause ripple noise on the display. Therefore, please adjust inverter frequency, and keep inverter as far from module as possible or use electronic shielding between inverter and module to avoid the interference.

\*3) 1. Starting Lamp Voltage: Vs = initial value Vs

2. Definition of starting lamp voltage means max. voltage of starting lamp. We suggest the inverter starting voltage greater than max. voltage of starting lamp to certify starting lamp stability.

\*4) Definition of the lamp life time : Luminance(L) under 50% of specification starting lamp voltage.

\*5) Test condition of Turn on and off life : Turn on and off lamp at IL=8.0mA and (Ta=25  $\pm$  5°C). The frequency is 10 sec.(on) on/ 10 sec. (off) and go on 100,000 times repeatedly.

HANTRONIX, INC. 10080 BUBB RD. CUPERTINO, CA 95014	Q.A.:	REV.:	HDA1040X	SHEET 7 OF 15
	Z.W.	1.0		DATE: 7/28/08

## INTERFACE CONNECTION

CN1

LCD connector (30pin) : STARCONN · P/N : 093F30 or other of the same class

Link connector : FI-X30H(JAE,Link Type) or other of the same class

Pin NO.	SYMBOL	DESCRIPTION
1	GND	Ground
2	V	+3.3V Power
3	V	+3.3V Power
4	NC	NC
5	NC	NC
6	NC	NC
7	GND	Ground
8	RXIN0-	LVDS Signal(-)—channel 0
9	RXIN0+	LVDS Signal(+)—channel 0
10	GND	Ground
11	RXIN1-	LVDS Signal(-)—channel 1
12	RXIN1+	LVDS Signal(+)—channel 1
13	GND	Ground
14	RXIN2-	LVDS Signal(-)—channel 2
15	RXIN2+	LVDS Signal(+)—channel 2
16	GND	Ground
17	RXCLKIN-	LVDS Clock Signal(-)
18	RXCLKIN+	LVDS Clock Signal(+)
19	GND	Ground
20	NC	NC
21	NC	NC
22	GND	Ground
23	GND	Ground
24	NC	NC
25	NC	NC
26	NC	NC
27	NC	NC
27	NC	NC
29	NC	NC
30	NC	NC

Remarks :

- 1) NC Pin : don't connect any signal or ground.
- 2) GND Pin : grounding pin, don't to floating.

HANTRONIX, INC. 10080 BUBB RD. CUPERTINO, CA 95014	Q.A.:	REV.:	HDA1040X	SHEET 8 OF 15
	Z.W.	1.0		DATE: 7/28/08

## INPUT SIGNAL(DE ONLY MODE)

### Timing Specification

Item	Symbol	Min	Typ	Max	Unit		
LVDS input signal sequence	CLK Frequency	fCLKin	51	65	71	MHz	
LCD input signal sequence (Input LVDS Transmitter)	Horizontal	Horizontal Total Time	t <sub>H</sub>	1160	1344	1350	tCLK
		Horizontal Effective Time	t <sub>HA</sub>	1024			tCLK
		Horizontal Blank Time	t <sub>HB</sub>	136	320	326	tCLK
	Vertical	Frame	fV	55	60	65	Hz
		Vertical Total Time	t <sub>V</sub>	790	806	810	t <sub>H</sub>
		Vertical Effective Time	t <sub>VA</sub>	768			t <sub>H</sub>
		Vertical Blank Time	t <sub>VB</sub>	22	38	42	t <sub>H</sub>

[Note]

\*1) Data is latched during DCLK falling period.(LVDS MODE)

\*2) DENA (DATA ENABLE) usually is positive.

### 5.2 Timing sequence(Timing chart)

#### 5.2.1 Horizontal Timing Sequence

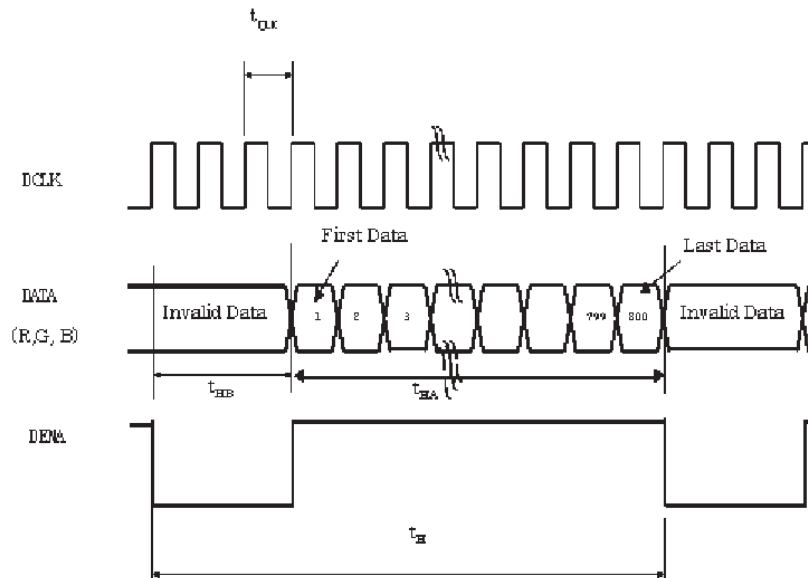

Color data assignment

COLOR	INPUT	R DATA					G DATA					B DATA						
		R5	R4	R3	R2	R1	R0	G5	G4	G3	G2	G1	G0	B5	B4	B3	B2	B1
	DATA	MSB				LSB	MSB				LSB	MSB					LSB	
BASIC COLOR	BLACK	0	0	0	0	0	0	0	0	0	0	0	0	0	0	0	0	0
	RED(63)	1	1	1	1	1	1	0	0	0	0	0	0	0	0	0	0	
	GREEN(63)	0	0	0	0	0	0	1	1	1	1	1	1	0	0	0	0	
	BLUE(63)	0	0	0	0	0	0	0	0	0	0	0	0	1	1	1	1	
	CYAN	0	0	0	0	0	0	1	1	1	1	1	1	1	1	1	1	
	MAGENTA	1	1	1	1	1	1	0	0	0	0	0	0	1	1	1	1	
	YELLOW	1	1	1	1	1	1	1	1	1	1	1	1	0	0	0	0	
	WHITE	1	1	1	1	1	1	1	1	1	1	1	1	1	1	1	1	
RED	RED(0)	0	0	0	0	0	0	0	0	0	0	0	0	0	0	0	0	
	RED(1)	0	0	0	0	0	1	0	0	0	0	0	0	0	0	0	0	
	RED(2)	0	0	0	0	1	0	0	0	0	0	0	0	0	0	0	0	
	RED(62)	1	1	1	1	1	0	0	0	0	0	0	0	0	0	0	0	
	RED(63)	1	1	1	1	1	1	0	0	0	0	0	0	0	0	0	0	
GREEN	GREEN(0)	0	0	0	0	0	0	0	0	0	0	0	0	0	0	0	0	
	GREEN(1)	0	0	0	0	0	0	0	0	0	0	1	0	0	0	0	0	
	GREEN(2)	0	0	0	0	0	0	0	0	0	1	0	0	0	0	0	0	
	GREEN(62)	0	0	0	0	0	0	1	1	1	1	1	0	0	0	0	0	
	GREEN(63)	0	0	0	0	0	0	1	1	1	1	1	1	0	0	0	0	
BLUE	BLUE(0)	0	0	0	0	0	0	0	0	0	0	0	0	0	0	0	0	
	BLUE(1)	0	0	0	0	0	0	0	0	0	0	0	0	0	0	0	1	
	BLUE(2)	0	0	0	0	0	0	0	0	0	0	0	0	0	0	1	0	
	BLUE(62)	0	0	0	0	0	0	0	0	0	0	0	0	1	1	1	1	
	BLUE(63)	0	0	0	0	0	0	0	0	0	0	0	0	1	1	1	1	

Remarks:

(1)Definition of Gray Scale

color(n) : n is series of Gray Scale. The more n value is the bright Gray Scale.

(2)Data:1-High,0-Low

HANTRONIX, INC. 10080 BUBB RD. CUPERTINO, CA 95014	Q.A.:	REV.:	HDA1040X	SHEET 10 OF 15
	Z.W.	1.0		DATE: 7/28/08

# BLOCK DIAGRAM

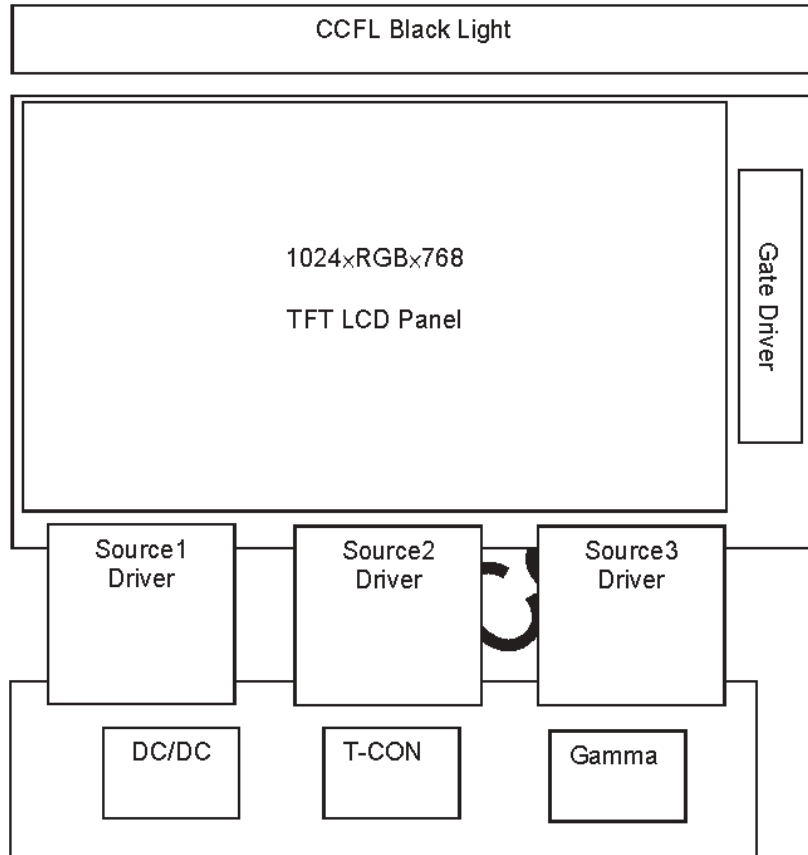

HANTRONIX, INC. 10080 BUBB RD. CUPERTINO, CA 95014	Q.A.:	REV.:	HDA1040X	SHEET 11 OF 15
	Z.W.	1.0		DATE: 7/28/08

## OPTICAL CHARACTERISTICS

Ta = 25°C, VCC=3.3V

ITEM	SYMBOL	CONDITION	MIN.	TYP.	MAX.	UNIT	Remarks	
Constrast Ratio	CR	Point-5	--	500	--	--	*1)*2)*3)	
Luminance(CEN)	Lw	Point-5	240	300	--	cd/m <sup>2</sup>	*1)*3)	
Luminance Uniformity	ΔL		70	80	-	%	*1)*3)	
Response Time (White - Black)	Tr +Tf	Point-5		25		ms	*1)*3)*5)	
Viewing Angle	Horizontal	• •	CR ≥ 10 Point-5	130	140	--	°	*1)*2)*4)
	Vertical	• •		110	120	--	°	*1)*2)*4)
Color Coordinate	White	Wx Wy	Point-5	0.273 0.289	0.313 0.329	0.353 0.369	--	*1)*3)
	Red	Rx Ry		0.545 0.286	0.585 0.326	0.625 0.366		
	Green	Gx Gy		0.264 0.550	0.304 0.590	0.344 0.630		
	Blue	Bx By		0.116 0.082	0.156 0.122	0.196 0.162		

Remarks :

\*1)Measure condition : 25 ± 2 ° , 60 ± 10%RH , under 10 Lux in the dark room.BM-5A (TOPCON) , viewing angle 2° , VCC=3.3V.

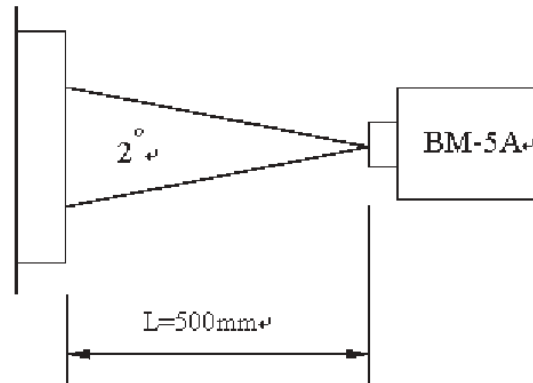

\*2) Definition of contrast ratio :

Contrast Ratio (CR)= (White) Luminance of ON ÷ (Black) Luminance of OFF

HANTRONIX, INC. 10080 BUBB RD. CUPERTINO, CA 95014	Q.A.:  Z.W.	REV.:  1.0	<h3 style="margin: 0;">HDA1040X</h3>	SHEET 12 OF 15  DATE: 7/28/08
--	-------------------	------------------	--------------------------------------	-------------------------------------

Definition of luminance : Measure white luminance on the point 5 as figure8-1  
 Definition of Luminance Uniformity: Measure white luminance on the point1-9 as figure8-1  
 •  $L = [L(\text{MIN})/L(\text{MAX})] \times 100$

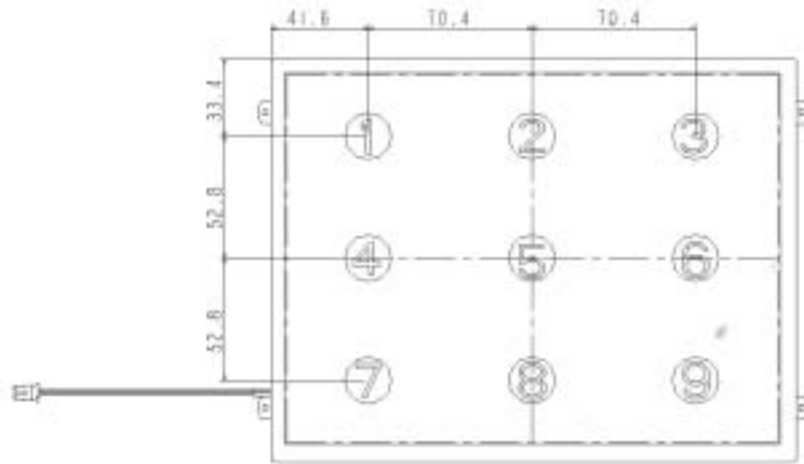

Fig8-1 Measuring point

\*4) Definition of Viewing Angle( $\theta, \psi$ ), refer to Fig8-2 as below :

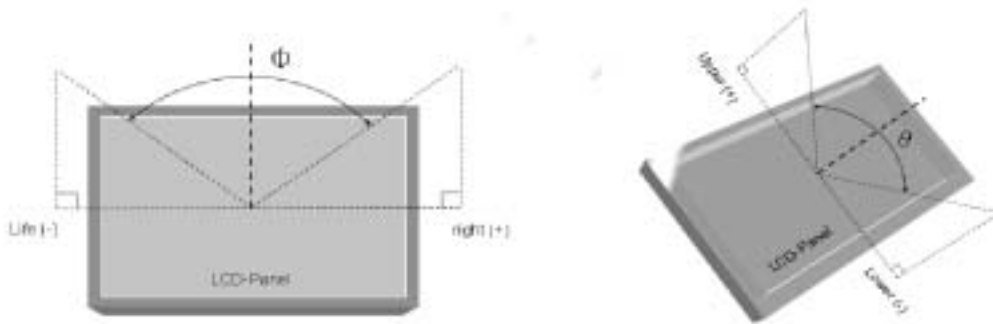

Fig8-2 Definition of Viewing Angle

\*5) Definition of Response Time.(White-Black)

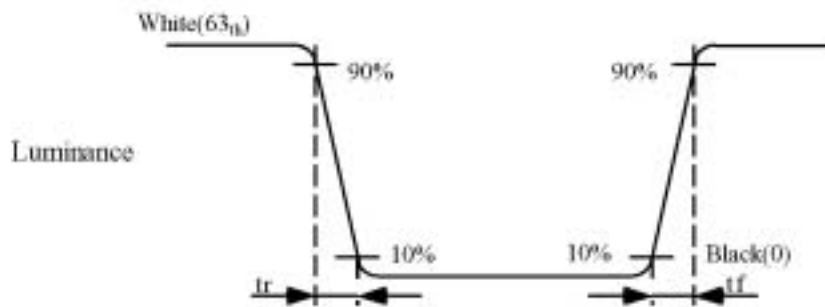

Fig8-3 Definition of Response Time(White-Black)

HANTRONIX, INC. 10080 BUBB RD. CUPERTINO, CA 95014	Q.A.:	REV.:	HDA1040X	SHEET 13 OF 15
	Z.W.	1.0		DATE: 7/28/08

## RELIABILITY TEST

### Temperature and humidity

TEST ITEMS	CONDITIONS
High Temperature Operation	70°C , 240Hrs
High Temperature Storage	80°C , 240Hrs
High Temperature High Humidity Operation	60°C , 90%RH , 240Hrs
Low Temperature Operation	-20°C , 240Hrs
Low Temperature Storage	-30°C , 240Hrs
Thermal Shock(No operation)	-30°C ( 0.5Hr) ~ 80°C(0.5Hr) , 200 cycles

### Shock and Vibration

TEST ITEMS	CONDITIONS
Shock (Non-operation)	<ul style="list-style-type: none"> <li>● Shock level:980m/s<sup>2</sup>(equal to 100G)</li> <li>● Waveform:half sinusoidal wave,6ms.</li> <li>● Number of shocks:one shock input in each direction of three mutually perpendicular axes for a total of three shock inputs.</li> </ul>
Vibration (Non-operation)	<ul style="list-style-type: none"> <li>● Frequency range:8~33.3Hz</li> <li>● Amplitude:1.3mm,33.3~400Hz</li> <li>● Vibration:sinusoidal wave,perpendicularaxis(both x, z axis:2Hrs, y axis 4Hrs).</li> <li>● Acceleration:2.9G</li> <li>● Sweep Cycle time:15min</li> </ul>

### ESD Test

ITEM	CONDITION	REMARK
ESD	150pF , 330Ω , ±8KV&±15KV air & contact test	*1)
	200pF , 0Ω , ±200V contact test	*2)

Remarks :

\*1) LCD glass and metal bezel

\*2) IF connector pins

· MTBF

CCFL:With BL : 30,000 Hrs (typ) lifetimes.

Judgment standard

The Judgment of the above test should be made as follow:

Pass:Normal display image with no obvious non-uniformity and no line defect.Partial transformation of the module parts should be ignored.

Fail:No display image,obvious non-uniform

HANTRONIX, INC. 10080 BUBB RD. CUPERTINO, CA 95014	Q.A.:	REV.:	HDA1040X	SHEET 14 OF 15
	Z.W.	1.0		DATE: 7/28/08

# MECHANICAL DIMENSION

## Front Side

[U Nit - mm]

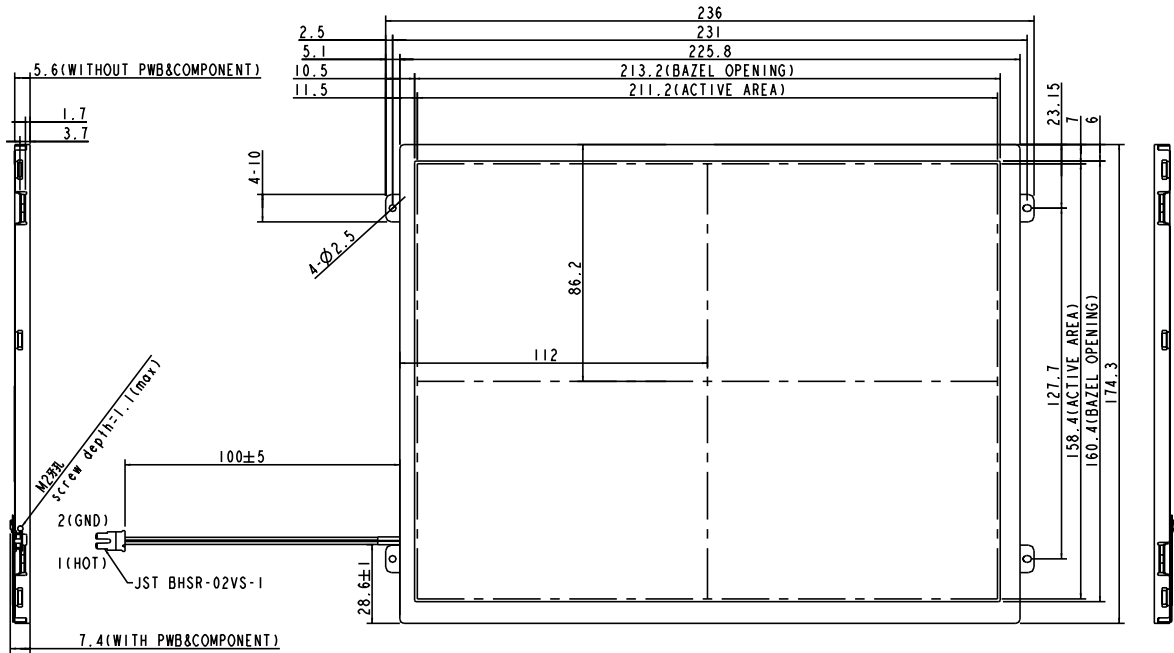

Remark? General tolerance?  $\pm 0.3\text{mm}$

?

## 7.2 Rear Side

[Unit? mm]

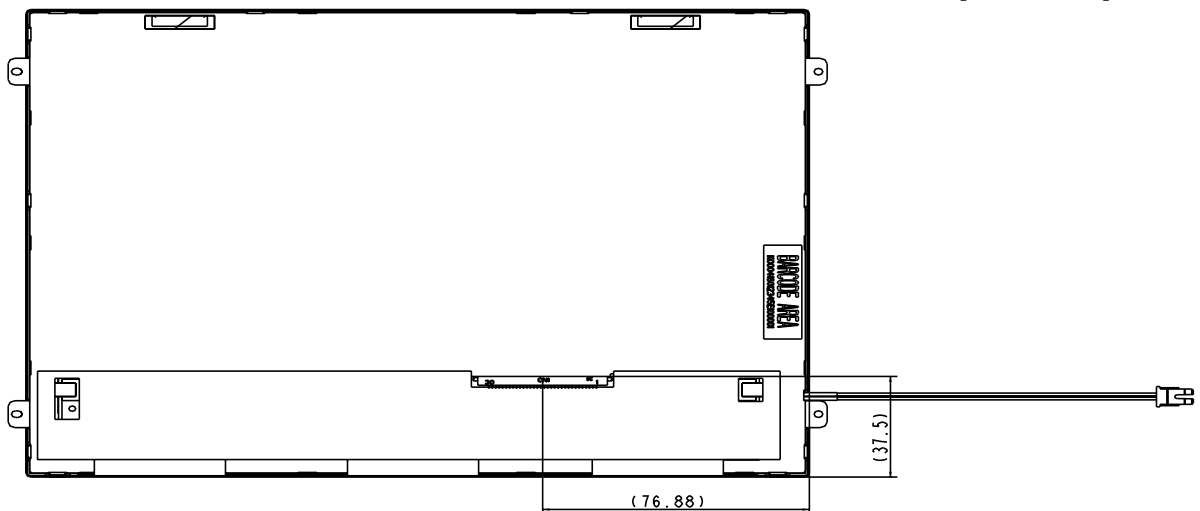

?

Remark? General tolerance?  $\pm 0.3\text{mm}$

HANTRONIX, INC. 10080 BUBB RD. CUPERTINO, CA 95014	Q.A.:	REV.:	HDA1040X	SHEET 15 OF 15
	Z.W.	1.0		DATE: 7/28/08