

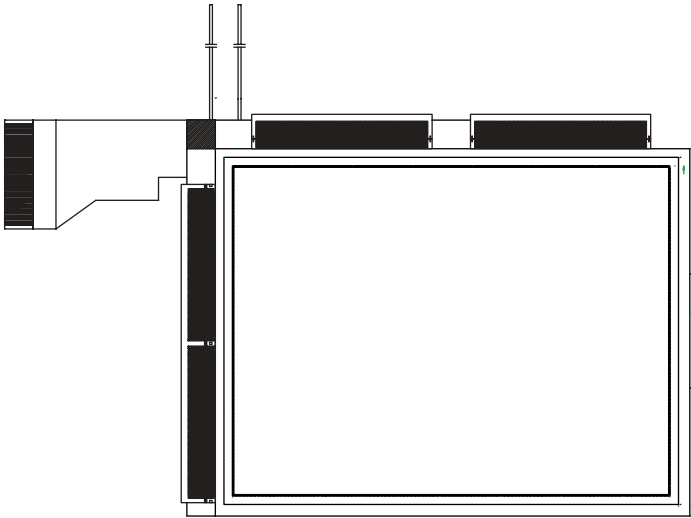

PRODUCT SPECIFICATION

# HDM3224L-G

320 x240 MONOCHROME GRAPHICS  
LCD DISPLAY MODULE



HANTRONIX, INC. 10080 BUBB RD. CUPERTINO, CA 95014	Q.A.:	REV:	HDM3224L-G	SHEET 1 OF 12
	ZW	1.0		DATE: 8/16/06

# 1. General Specifications

## 1-1.Features

- A. Drive Method:1/240 Duty, 1/13 Bias
- B. The Module Operating Voltage: 3.0V;
- C. The LCD Operating Voltage :22.0V;
- D. Viewing Direction: 9:00
- E. Operating Temperature: -20 ° C ~70 ° C
- F. Storage Temperature: -30 ° C ~85 ° C
- G. Display type: FSTN Positive

## 1-2.Mechanical Data:

- (1) Module Size ----- 88.3W \* 69.1 H \* 6.5 L mm
- (2) Viewing Area ----- 79.8 W \* 60.6 H mm
- (3) Dot Size ----- 0.225 W \* 0.225 H mm
- (4) Dot Matrix----- 320 \* 240
- (5) Outline Dimensions----- See Attached Drawing

## 1-3 . Absolute Maximum Ratings

Characteristics	Symbol	Ratings
Power Supply Voltage	VDD	-0.3V to +7.0V
Driver supply voltage	V0	-0.3V to +30V
Input Voltage	V <sub>IN</sub>	-0.3V to Vdd+0.3V

1-4.Pin Connections:

Pin No.	Symbol	Function
1-6	VLCD ,V6, V3,V4 V5,V2	Power supply pin for LCD driver voltage
7	GND	Ground
8	VDD	Power Supply
9	FLM	First line marker
10	CL2	Display data shift clock input for segment mode
11	M	AC signal
12	CL1	Latch pulse input/shift clock input for the shift register
13	/DOFF	Control input for deselect output level
14	GND	Ground
15-18	D3-D0	Display data

# 1-5.DC Characteristics

Segment Mode ( $V_{SS} = V_S = 0V$ ,  $V_{DD} = 2.5 - 5.5V$ ,  $V_O = 15$  to  $30V$ , and  $T_A = -30$  to  $+85^\circ C$ , unless otherwise noted)

Parameter	Symbol	Min.	Typ.	Max.	Unit	Condition
Operating Voltage	$V_{DD}$	2.5	-	5.5	V	
Operating Voltage	$V_O$	15	-	30	V	
Input high voltage	$V_{IH}$	$0.8 V_{DD}$	-	-	V	D0 - 7, XCK, LP, L/R, FR, MD, S/C, EIO <sub>1</sub> , EIO <sub>2</sub> and $\overline{DISPOFF}$ pins
Input low voltage	$V_{IL}$	-	-	$0.2 V_{DD}$	V	
Output high voltage	$V_{OH}$	$V_{DD} - 0.4$	-	-	V	EIO <sub>1</sub> , EIO <sub>2</sub> pins, $I_{OH} = -0.4mA$
Output low voltage	$V_{OL}$	-	-	+0.4	V	EIO <sub>1</sub> , EIO <sub>2</sub> pins, $I_{OL} = +0.4mA$
Input leakage current 1	$I_{IH}$	-	-	+1	$\mu A$	D0 - 7, XCK, LP, L/R, FR, MD, S/C, EIO <sub>1</sub> , EIO <sub>2</sub> and $\overline{DISPOFF}$ pins, $V_i = V_{DD}$
Input leakage current 2	$I_{IL}$	-	-	-1	$\mu A$	D0 - 7, XCK, LP, L/R, FR, MD, S/C, EIO <sub>1</sub> , EIO <sub>2</sub> and $\overline{DISPOFF}$ pins, $V_i = V_{SS}$
Output resistance	$R_{OH}$	-	1.0	1.5	k $\Omega$	$V_O = +30.0V$ $V_O = +20.0V$ Y <sub>1</sub> - Y <sub>50</sub> pins, $ V_{OH}  = 0.5V$
		-	1.5	2.0		
Stand-by current	$I_{SB}$	-	-	5	$\mu A$	$V_{SS}$ pin, Note 1
Consumed current (1) (Deselection)	$I_{DD1}$	-	-	2.0	mA	$V_{DD}$ pin, Note 2
Consumed current (2) (Selection)	$I_{DD2}$	-	-	8.0	mA	$V_{DD}$ pin, Note 3
Consumed current	$I_O$	-	-	1.0	mA	$V_O$ pin, Note 4

Note:

- $V_{DD} = +5.0V$ ,  $V_O = +30V$ ,  $V_i = V_{SS}$
- $V_{DD} = +5.0V$ ,  $V_O = +30V$ ,  $f_{XCK} = 14MHz$ , No-load,  $EI = V_{DD}$   
The input data is turned over by the data taking clock (4-bit parallel input mode)
- $V_{DD} = +5.0V$ ,  $V_O = +30V$ ,  $f_{XCK} = 14MHz$ , No-load,  $EI = V_{SS}$   
The input data is turned over by the data taking clock (4-bit parallel input mode)
- $V_{DD} = +5.0V$ ,  $V_O = +30V$ ,  $f_{XCK} = 14MHz$ ,  $f_{LP} = 41.6kHz$ ,  $f_{FR} = 80Hz$ , No-load  
The input data is turned over by the data taking clock (4-bit parallel-input mode)

Common Mode ( $V_{SS} = V_S = 0V$ ,  $V_{DD} = 2.5 - 5.5V$ ,  $V_O = 15$  to  $30V$ , and  $T_A = -30$  to  $+85^\circ C$ , unless otherwise noted)

Parameter	Symbol	Min.	Typ.	Max.	Unit	Condition
Operating Voltage	$V_{DD}$	2.5	-	5.5	V	
Operating Voltage	$V_O$	15	-	30	V	
Input high voltage	$V_{IH}$	$0.8 V_{DD}$	-	-	V	D0 - 7, XCK, LP, L/R, FR, MD, S/C, EIO <sub>1</sub> , EIO <sub>2</sub> , $\overline{DISPOFF}$ pins
Input low voltage	$V_{IL}$	-	-	$0.2 V_{DD}$	V	
Output high voltage	$V_{OH}$	$V_{DD} - 0.4$	-	-	V	EIO <sub>1</sub> , EIO <sub>2</sub> pins, $I_{OH} = -0.4mA$
Output low voltage	$V_{OL}$	-	-	+0.4	V	EIO <sub>1</sub> , EIO <sub>2</sub> pins, $I_{OL} = +0.4mA$
Input leakage current 1	$I_{IH}$	-	-	+10.0	$\mu A$	D0 - 6, LP, L/R, FR, MD, S/C and $\overline{DISPOFF}$ pins, $V_i = V_{DD}$
Input leakage current 2	$I_{IL}$	-	-	-10.0	$\mu A$	D0 - 7, XCK, LP, L/R, FR, MD, S/C, EIO <sub>1</sub> , EIO <sub>2</sub> , $\overline{DISPOFF}$ pins, $V_i = V_{SS}$
Input pull down current	$I_{PD}$	-	-	100	$\mu A$	XCK, EIO <sub>1</sub> , EIO <sub>2</sub> , D7 pins
Output resistance	$R_{OH}$	-	1.5	2.0	k	Y <sub>1</sub> - Y <sub>240</sub> pins, $ V_{OH}  = 0.5V$
		-	2.0	2.5		
Stand-by current	$I_{SB}$	-	-	75	$\mu A$	$V_{SS}$ pin, Note 1
Consumed current (1)	$I_{DD}$	-	-	120	$\mu A$	$V_{DD}$ pin, Note 2
Consumed current (2)	$I_O$	-	-	240	$\mu A$	$V_O$ pin, Note 2

Note:

- $V_{DD} = +5.0V$ ,  $V_O = +30.0V$ ,  $V_i = V_{SS}$
- $V_{DD} = +5.0V$ ,  $V_O = +30.0V$ ,  $f_{LP} = 41.6kHz$ ,  $f_{FR} = 80Hz$ , case of 1/480 duty operation, No-load

HANTRONIX, INC.  
10080 BUBB RD.  
CUPERTINO, CA 95014

Q.A.:  
Z.W.

REV.:  
1.0

HDM3224L-G

SHEET 4 OF 12

DATE:  
8/16/06

## 1-6.AC Characteristics

Segment Mode 1 ( $V_{SS} = V_S = 0V$ ,  $V_{DD} = 4.5 - 5.5V$ ,  $V_O = 15$  to  $30$ , and  $T_A = -30$  to  $+85^\circ C$ , unless otherwise noted)

Parameter	Symbol	Min.	Typ.	Max.	Unit	Condition
Shift clock period	twck	71	-		ns	$t_r, t_f \leq 10ns$ , Note 1
Shift clock "H" pulse width	twckH	23	-		ns	
Shift clock "L" pulse width	twckL	23	-		ns	
Data setup time	t <sub>ds</sub>	10	-		ns	
Data hole time	t <sub>dH</sub>	20	-		ns	
Latch pulse "H" pulse width	twLPH	23	-		ns	
Shift clock rise to Latch pulse rise time	t <sub>LD</sub>	0	-		ns	
Shift clock fall to Latch pulse fall time	t <sub>SL</sub>	25	-		ns	
Latch pulse rise to Shift clock rise time	t <sub>LS</sub>	25	-		ns	
Latch pulse fall to Shift clock rise time	t <sub>LH</sub>	25	-		ns	
Input signal rise time	t <sub>r</sub>		-	50	ns	Note 2
Input signal fall time	t <sub>f</sub>		-	50	ns	Note 2
Enable setup time	t <sub>s</sub>	21	-		ns	
$\overline{DISPOFF}$ Removal time	t <sub>SD</sub>	100	-		ns	
$\overline{DISPOFF}$ enable pulse width	twDL	1.2	-		$\mu s$	
Output delay time (1)	t <sub>d</sub>		-	40	ns	$C_L = 15pF$
Output delay time (2)	t <sub>pd1</sub> , t <sub>pd2</sub>		-	1.2	$\mu s$	$C_L = 15pF$
Output delay time (3)	t <sub>pd3</sub>		-	1.2	$\mu s$	$C_L = 15pF$

### Note

1. Take the cascade connection into consideration.
2.  $(T_{ck} - twckH - twckL)/2$  is the maximum in the case of high speed operation.

Common Mode ( $V_{SS} = V_S = 0V$ ,  $V_{DD} = 2.5 - 5.5V$ ,  $V_O = 15$  to  $30V$  and  $T_A = -30$  to  $+85^\circ C$ , unless otherwise noted)

Parameter	Symbol	Min.	Typ.	Max.	Unit	Condition
Shift clock period	twLP	250	-	-	ns	$t_r, t_f \leq 20ns$
Shift clock "H" pulse width	twLPH	15	-	-	ns	$V_{DD} = +5.0V \pm 10\%$
		30	-	-	ns	$V_{DD} = +2.5 - +4.5V$
Data setup time	t <sub>su</sub>	30	-	-	ns	
Data hole time	t <sub>H</sub>	50	-	-	ns	
Input signal rise time	t <sub>r</sub>		-	50	ns	
Input signal fall time	t <sub>f</sub>		-	50	ns	
$\overline{DISPOFF}$ Removal time	t <sub>SD</sub>	100	-	-	ns	
$\overline{DISPOFF}$ enable pulse width	twDL	1.2	-	-	$\mu s$	
Output delay time (1)	t <sub>dL</sub>	-	-	200	ns	$C_L = 15pF$
Output delay time (2)	t <sub>pd1</sub> , t <sub>pd2</sub>	-	-	1.2	$\mu s$	$C_L = 15pF$
Output delay time (3)	t <sub>pd3</sub>	-	-	1.2	$\mu s$	$C_L = 15pF$

HANTRONIX, INC.  
10080 BUBB RD.  
CUPERTINO, CA 95014

Q.A.:  
Z.W.

REV.:  
1.0

HDM3224L-G

SHEET 5 OF 12

DATE:  
8/16/06



## Timing Characteristics of Common Mode

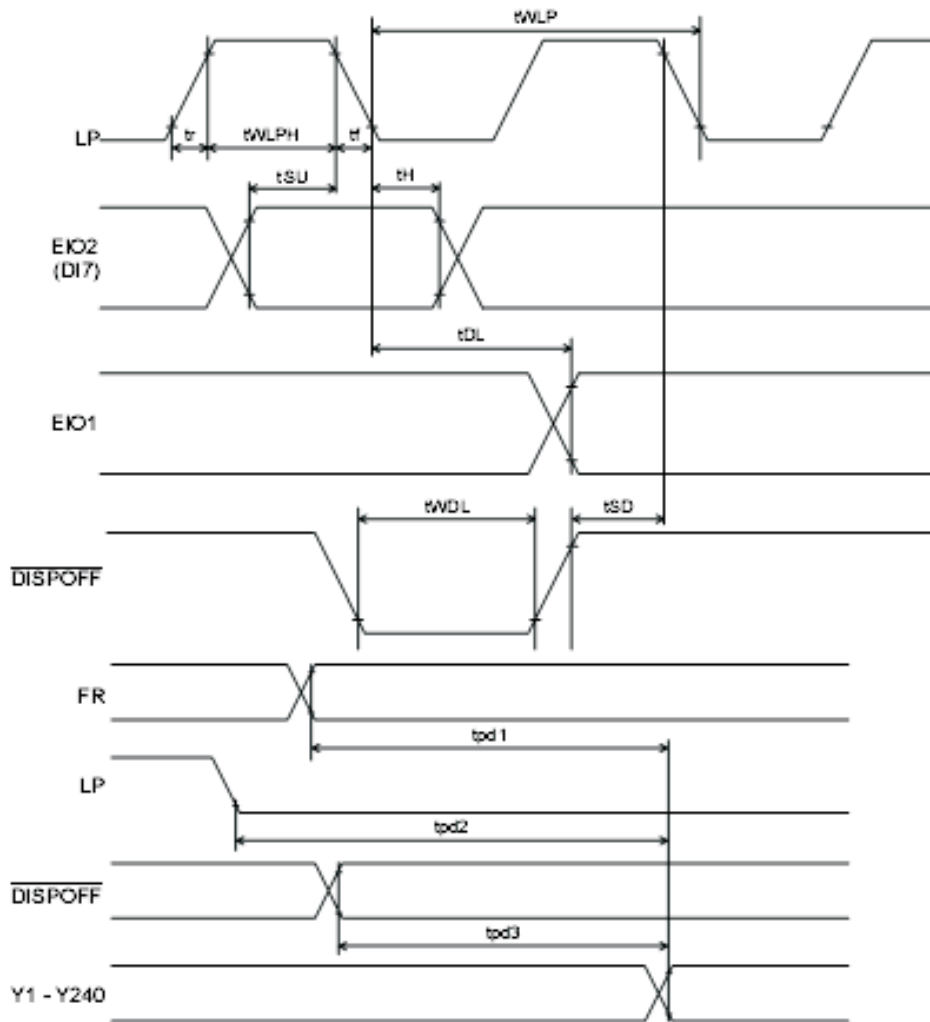

HANTRONIX, INC.  
10080 BUBB RD.  
CUPERTINO, CA 95014

Q.A.:  
Z.W.

REV.:  
1.0

HDM3224L-G

SHEET 7 OF 12

DATE:  
8/16/06

## 2.The Characteristics and The Reliability Test

### 2- 1.Electro-Optic Characteristics:

V<sub>dd</sub> 3.3V

Condition:TEMP=(23 ± 3)° C

Hum=(70 ± 5)%RH

NO	Item	Symbol	Min	Typ.	Max	Unit	Condition
1	Supply Voltage(Logic)	Vdd-Vss		3.0		V	
2	LCD Operating Voltage	VLCD		22.4		V	-20 °C
				22.0		V	25 °C
				21.6		V	70 °C
3	Response Time	Ton		140		ms	
		Toff		344		ms	
4	Contrast	CR	3				
5	Viewing Angel	12H	∅1		50	Deg	(CR ≥3.0)
		6H	∅2		55		
		3H	∅3		40		
		9H	∅4		40		
6	LCD Threshold Voltage	Vth		18.8		V	25 °C

:

### 2. Characteristics of backlight

Item	Symbol	Min.	Typ.	Max.	Unit	Condition
Forward Voltage	VF	2.9	3.0	3.1	V	IF=60mA
Forward Current	IF		60		mA	
Reverse Voltage	VR		5.0		V	
Reverse Current	IR			10	uA	
Color	WHITE					

WARNING:

A BACKLIGHT IS A KIND OF CURRENT DEVICE,IT MUST CONNECT A RESISTANCE FOR LIMITING CURRENT ,OR IT WILL BE DAMAGED.

HANTRONIX, INC. 10080 BUBB RD. CUPERTINO, CA 95014	Q.A.:	REV.:	HDM3224L-G	SHEET 8 OF 12
	Z.W.	1.0		DATE: 8/16/06



# The Equipment and LCD Measuring Method

## 1. Equipment

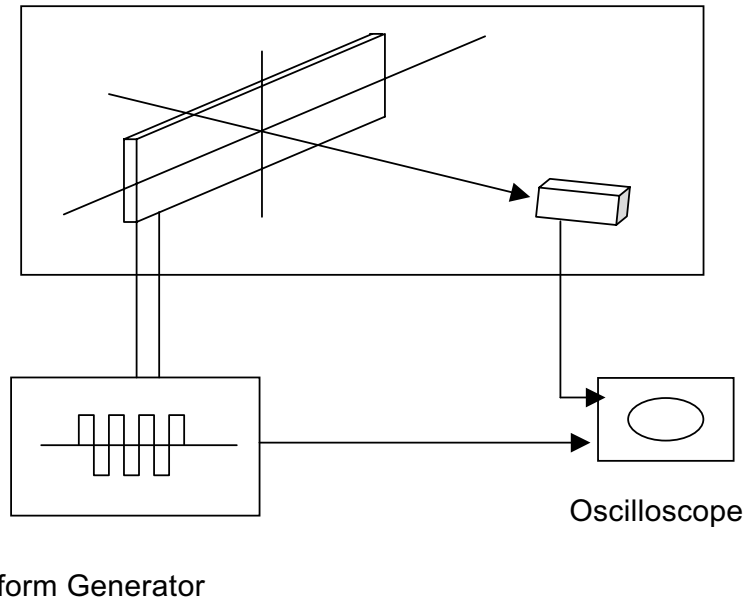

## (2) Definition

### a. Threshold Voltage ( $V_{th}$ )

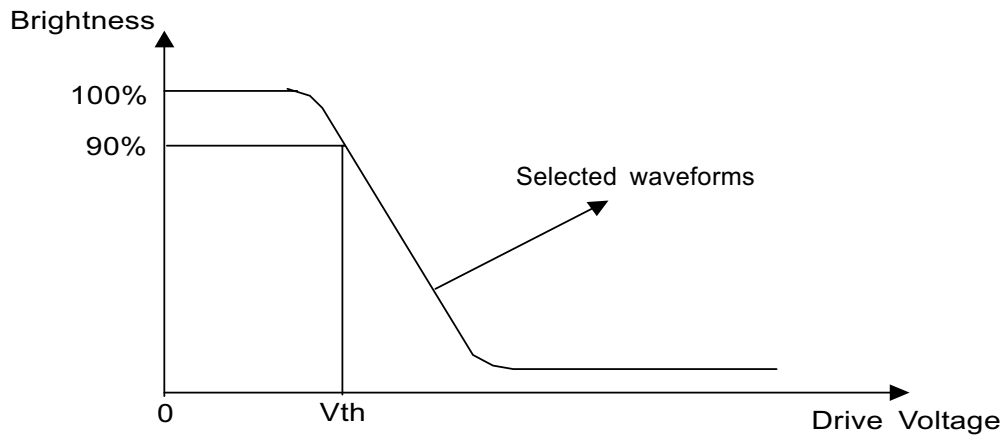

b. Response Time

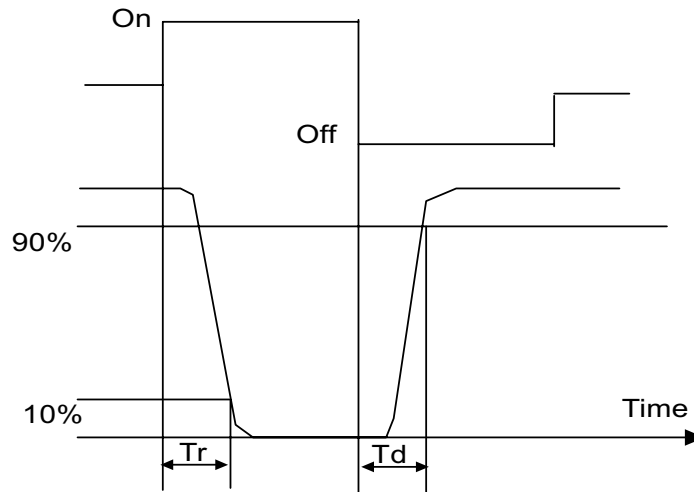

a. Viewing Angle:

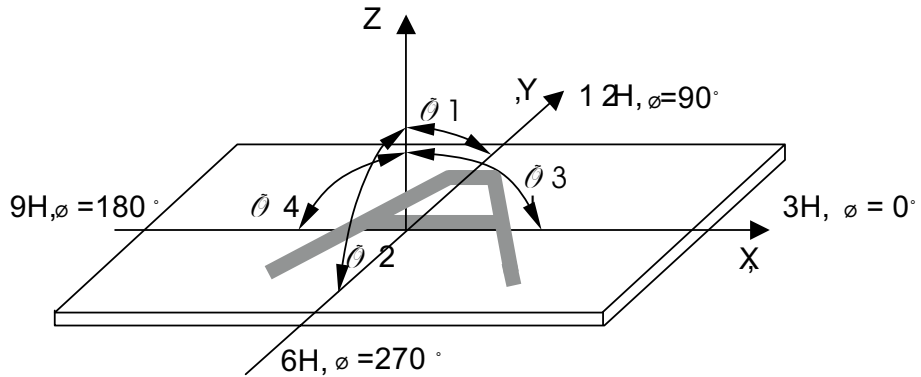

b. Contrast Ratio (positive)

$$CR = \frac{\text{Brightness of non-selected wave-form}}{\text{Brightness of selected wave-form}}$$

4. Reliability Test:

Equipment : Tenny

HANTRONIX, INC. 10080 BUBB RD. CUPERTINO, CA 95014	Q.A.:	REV.:	HDM3224L-G	SHEET 10 OF 12
	Z.W.	1.0		DATE: 8/16/06

## 2. Reliability Test

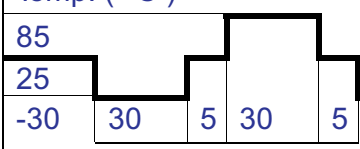
No	Items	Test Condition	Equipment	Test Result
1	High Temp Storage	Temp: $85 \pm 2$ °C Time:96h Restore:24h	Tenny	Passed
2	Low Temp Storage	Temp: $-30 \pm 3$ °C Time:96h Restore:24h	Tenny	Passed
3	High Temp Static drive	Temp: $70 \pm 2$ °C Vop:3.3V Time:24h Restore:24h	Tenny	Passed
4	Low Temp Static drive	Temp: $-2 \pm 2$ °C Vop:3.3V Time:24h Restore:24h	Tenny	Passed
5	High Temp High Hum Storage	Temp: $40 \pm 2$ °C Hum:95%Rh Time:96h Restore:24h	Tenny	Passed
6	Thermal Shock	Temp: ( °C )  5Cycles Restore:24h	Tenny	Passed

HANTRONIX, INC. 10080 BUBB RD. CUPERTINO, CA 95014	Q.A.:	REV.:	HDM3224L-G	SHEET 11 OF 12
	Z.W.	1.0		DATE: 8/16/06

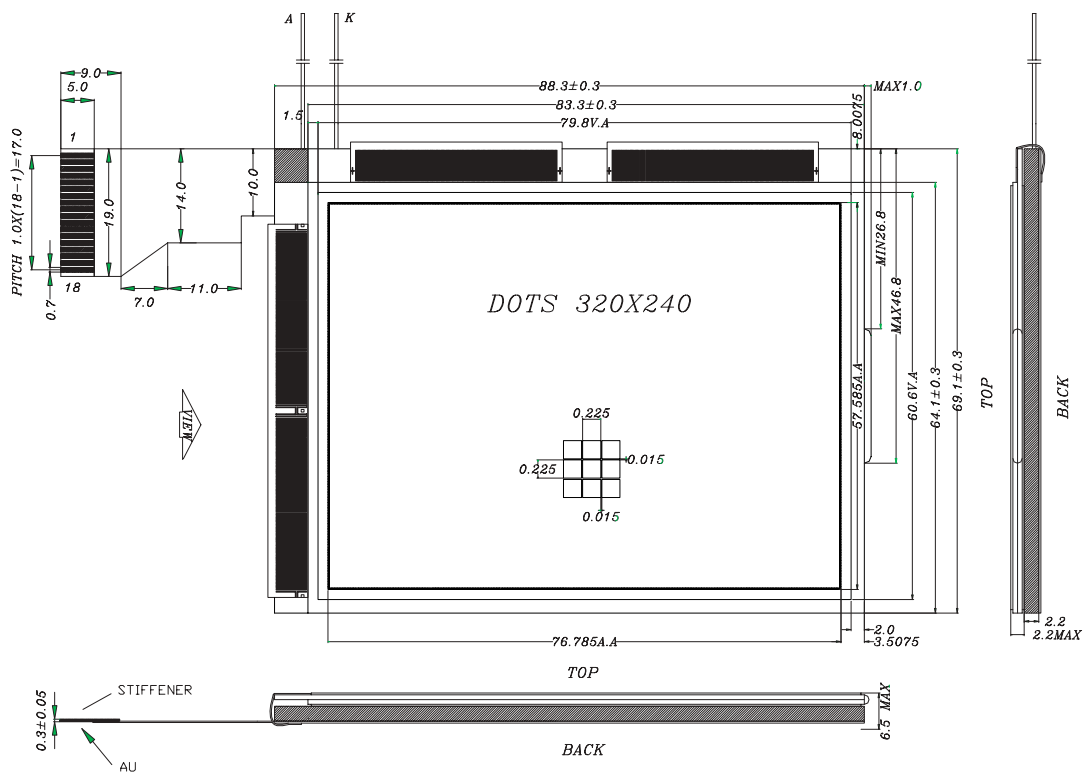

- Notes:
1. Operating Voltage: 3.0V; Vlcd: 22.0v
  2. Drive method: 1/240Duty, 1/13Bias
  3. Viewing Direction: 9:00
  4. Operating Temp: -20 C~70 C
  5. Storage Temp: -30 C~85 C
  6. Display Type: FSTN, Positive
  7. NT7701,NT7702

1	2	3	4	5	6	7	8	9
VLCBKV1	V6	V3	V4	V5	GNDKV2	GND	VDD	FLM
10	11	12	13	14	15	16	17	18
CLZ	M	CL1	DISPDDF	GND	D3	D2	D1	D0